

AO8830
Common-Drain Dual N-Channel Enhancement Mode Field Effect Transistor
General Description

The AO8830/L uses advanced trench technology to provide excellent $R_{DS(ON)}$, low gate charge and operation with gate voltages as low as 1.8V while retaining a 12V $V_{GS(MAX)}$ rating. This device is suitable for use as a uni-directional or bi-directional load switch, facilitated by its common-drain configuration. AO8830 and AO8830L are electrically identical.

- RoHs Compliant
- AO8830L is Halogen Free

Features

- V_{DS} (V) = 20V
- I_D = 6 A (V_{GS} = 10V)
- $R_{DS(ON)} < 27m\Omega$ (V_{GS} = 10V)
- $R_{DS(ON)} < 30m\Omega$ (V_{GS} = 4.5V)
- $R_{DS(ON)} < 37m\Omega$ (V_{GS} = 3.1V)
- $R_{DS(ON)} < 41m\Omega$ (V_{GS} = 2.5V)
- $R_{DS(ON)} < 55m\Omega$ (V_{GS} = 1.8V)

ESD PROTECTED!

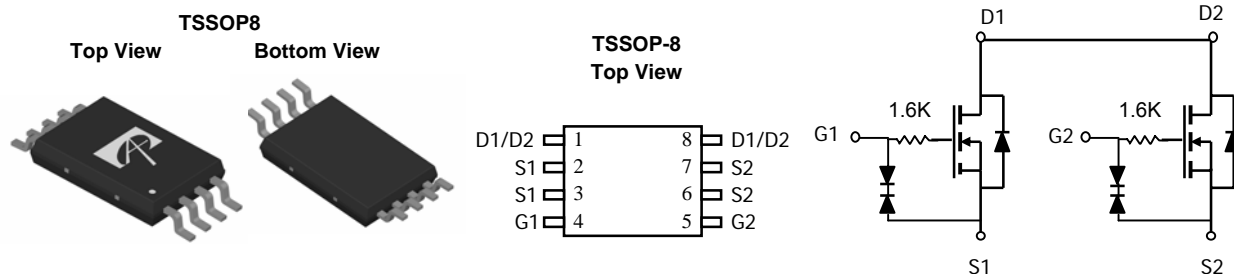
Absolute Maximum Ratings $T_A=25^\circ\text{C}$ unless otherwise noted

Parameter	Symbol	Maximum	Units
Drain-Source Voltage	V_{DS}	20	V
Gate-Source Voltage	V_{GS}	± 12	V
Continuous Drain Current ^A	$T_A=25^\circ\text{C}$	6	A
		$T_A=70^\circ\text{C}$	
Pulsed Drain Current ^B	I_{DM}	30	
Power Dissipation ^A	$T_A=25^\circ\text{C}$	1.5	W
		$T_A=70^\circ\text{C}$	
Junction and Storage Temperature Range	T_J, T_{STG}	-55 to 150	

Thermal Characteristics

Parameter	Symbol	Typ	Max	Units
Maximum Junction-to-Ambient ^A	$R_{\theta JA}$	64	83	$^\circ\text{C/W}$
Maximum Junction-to-Ambient ^A		Steady-State	115	
Maximum Junction-to-Lead ^C	$R_{\theta JL}$	70	85	$^\circ\text{C/W}$

Electrical Characteristics (T_J=25°C unless otherwise noted)

Symbol	Parameter	Conditions	Min	Typ	Max	Units
STATIC PARAMETERS						
BV _{DSS}	Drain-Source Breakdown Voltage	I _D =250μA, V _{GS} =0V	20			V
I _{DSS}	Zero Gate Voltage Drain Current	V _{DS} =16V, V _{GS} =0V T _J =55°C			1 5	μA
I _{GSS}	Gate-Body leakage current	V _{DS} =0V, V _{GS} =±10V			10	
BV _{GSO}	Gate-Source Breakdown Voltage	V _{DS} =0V, I _G =±250μA	±12			V
V _{GS(th)}	Gate Threshold Voltage	V _{DS} =V _{GS} , I _D =1mA	0.5	0.6	1	V
I _{D(ON)}	On state drain current	V _{GS} =4.5V, V _{DS} =5V	30			A
R _{DS(ON)}	Static Drain-Source On-Resistance	V _{GS} =10V, I _D =6A T _J =125°C	16	22	27	mΩ
		V _{GS} =4.5V, I _D =5A	19	25	30	mΩ
		V _{GS} =3.1V, I _D =4A	22	30	37	
		V _{GS} =2.5V, I _D =4A	25	32	41	mΩ
		V _{GS} =1.8V, I _D =2A	32	42	55	mΩ
g _{FS}	Forward Transconductance	V _{DS} =5V, I _D =6A		21		S
V _{SD}	Diode Forward Voltage	I _S =1A, V _{GS} =0V		0.75	1	V
I _S	Maximum Body-Diode Continuous Current				2.5	A
DYNAMIC PARAMETERS						
C _{iss}	Input Capacitance	V _{GS} =0V, V _{DS} =10V, f=1MHz		290		pF
C _{oss}	Output Capacitance			120		pF
C _{riss}	Reverse Transfer Capacitance			40		pF
R _g	Gate resistance	V _{GS} =0V, V _{DS} =0V, f=1MHz		1.6		kΩ
SWITCHING PARAMETERS						
Q _g	Total Gate Charge	V _{GS} =4.5V, V _{DS} =10V, I _D =6A		5.2		nC
Q _{gs}	Gate Source Charge			2.1		nC
Q _{gd}	Gate Drain Charge			1.9		nC
t _{D(on)}	Turn-On Delay Time	V _{GS} =4.5V, V _{DS} =10V, R _L =1.7Ω, R _{GEN} =3Ω		280		ns
t _r	Turn-On Rise Time			972		ns
t _{D(off)}	Turn-Off Delay Time			2.35		μs
t _f	Turn-Off Fall Time			2.2		μs
t _{rr}	Body Diode Reverse Recovery Time	I _F =6A, dI/dt=100A/μs, V _{GS} =-9V		25		ns
Q _{rr}	Body Diode Reverse Recovery Charge	I _F =6A, dI/dt=100A/μs, V _{GS} =-9V		8		nC

A: The value of R_{θJA} is measured with the device mounted on 1in² FR-4 board with 2oz. Copper, in a still air environment with T_A=25°C. The value in any given application depends on the user's specific board design. The current and power rating is based on the t_≤ 10s thermal resistance rating.

B: Repetitive rating, pulse width limited by junction temperature.

C: The R_{θJA} is the sum of the thermal impedance from junction to lead R_{θJL} and lead to ambient.

D: The static characteristics in Figures 1 to 6, 12, 14 are obtained using <300μs pulses, duty cycle 0.5% max.

E: These tests are performed with the device mounted on 1 in² FR-4 board with 2oz. Copper, in a still air environment with T_A=25°C. The SOA curve provides a single pulse rating.

Rev 5: July 2010

THIS PRODUCT HAS BEEN DESIGNED AND QUALIFIED FOR THE CONSUMER MARKET. APPLICATIONS OR USES AS CRITICAL COMPONENTS IN LIFE SUPPORT DEVICES OR SYSTEMS ARE NOT AUTHORIZED. AOS DOES NOT ASSUME ANY LIABILITY ARISING OUT OF SUCH APPLICATIONS OR USES OF ITS PRODUCTS. AOS RESERVES THE RIGHT TO IMPROVE PRODUCT DESIGN, FUNCTIONS AND RELIABILITY WITHOUT NOTICE.

TYPICAL ELECTRICAL AND THERMAL CHARACTERISTICS

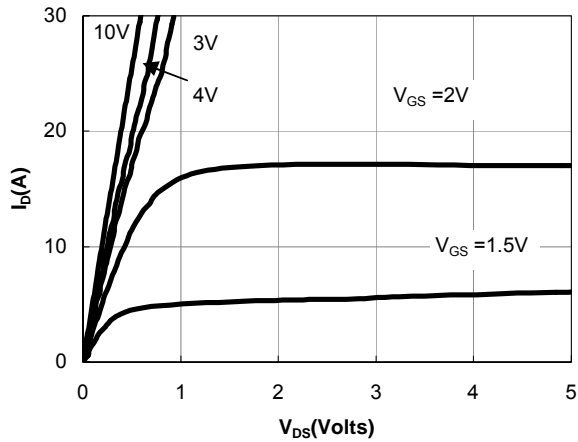

Figure 1: On-Regions Characteristics

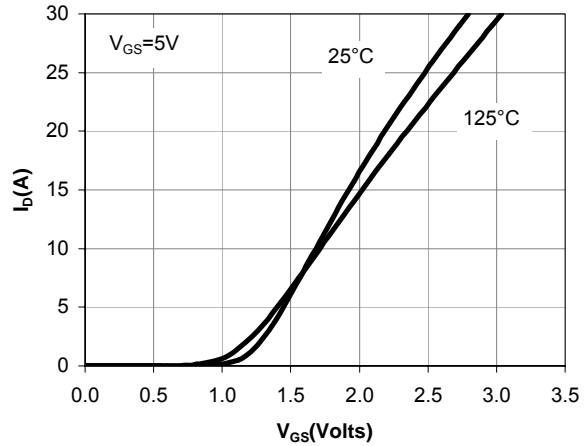

Figure 2: Transfer Characteristics

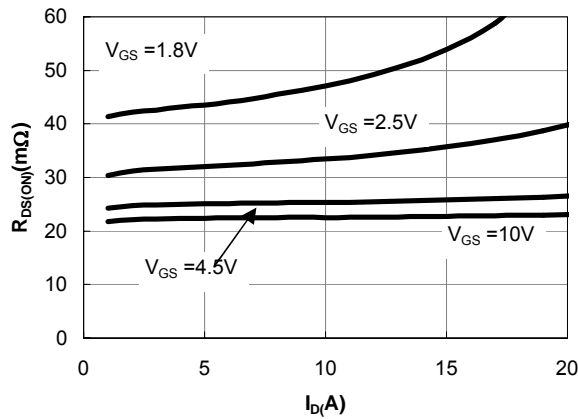

Figure 3: On-Resistance vs. Drain Current and Gate Voltage

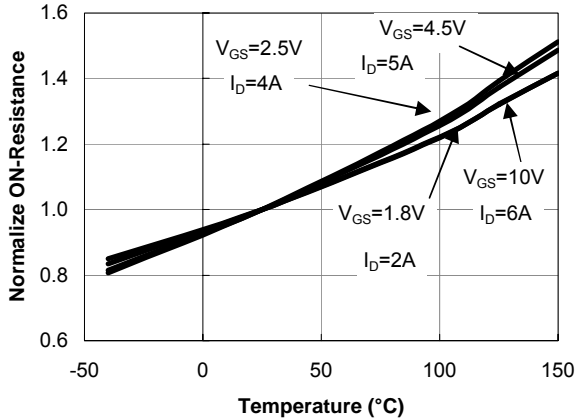

Figure 4: On-Resistance vs. Junction Temperature

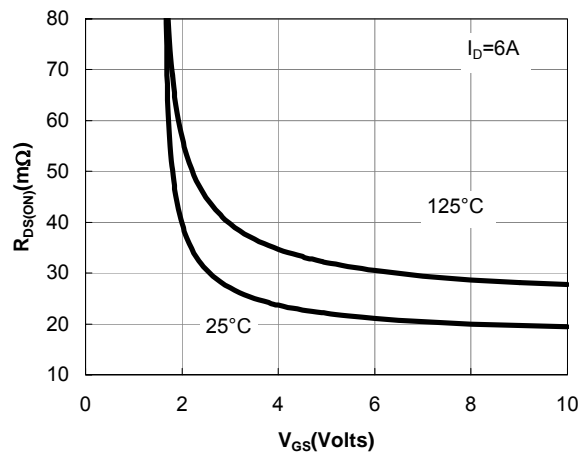

Figure 5: On-Resistance vs. Gate-Source Voltage

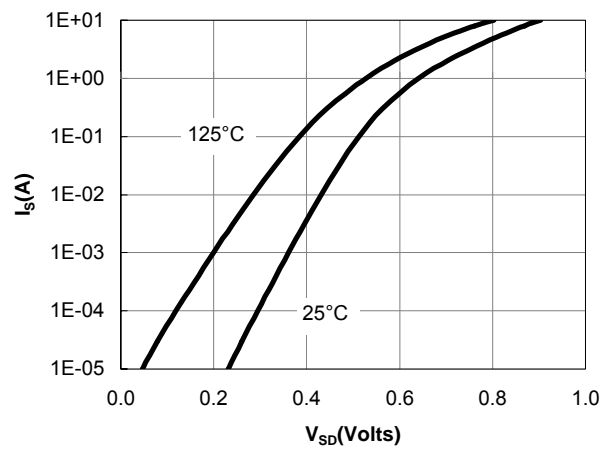

Figure 6: Body-Diode Characteristics

TYPICAL ELECTRICAL AND THERMAL CHARACTERISTICS

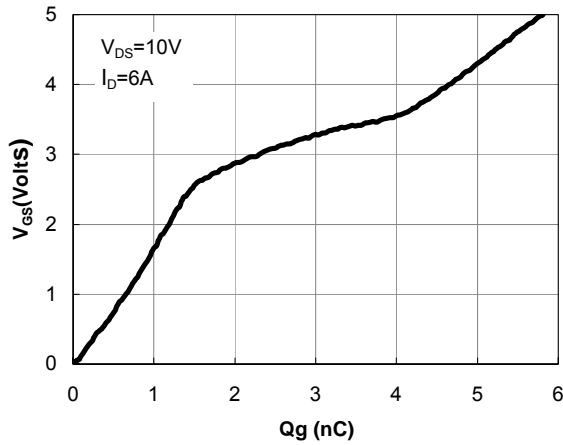

Figure 7: Gate-Charge Characteristics

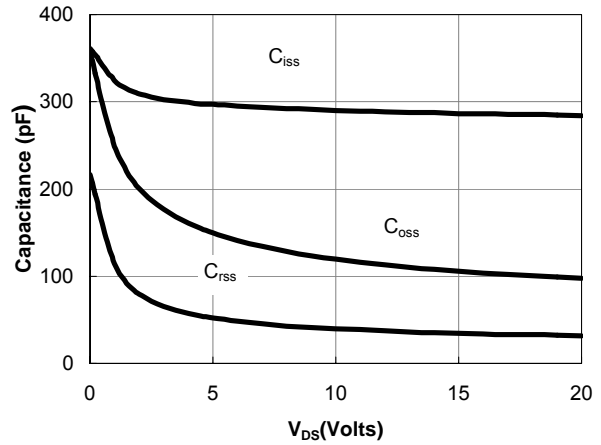

Figure 8: Capacitance Characteristics

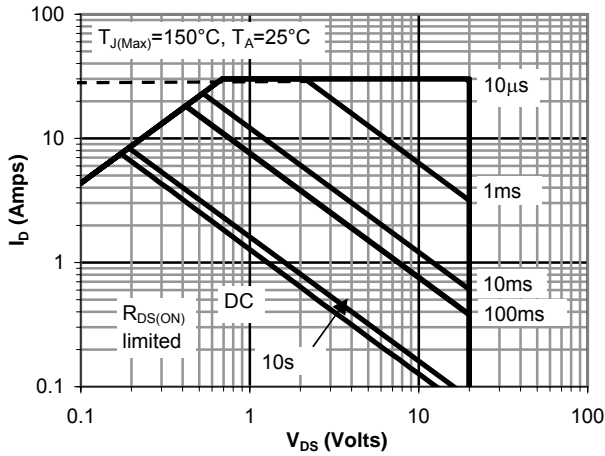

Figure 9: Maximum Forward Biased Safe Operating Area (Note E)

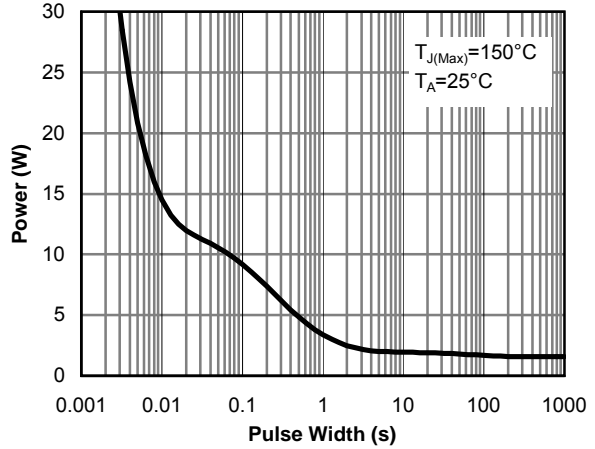

Figure 10: Single Pulse Power Rating Junction-to-Ambient (Note E)

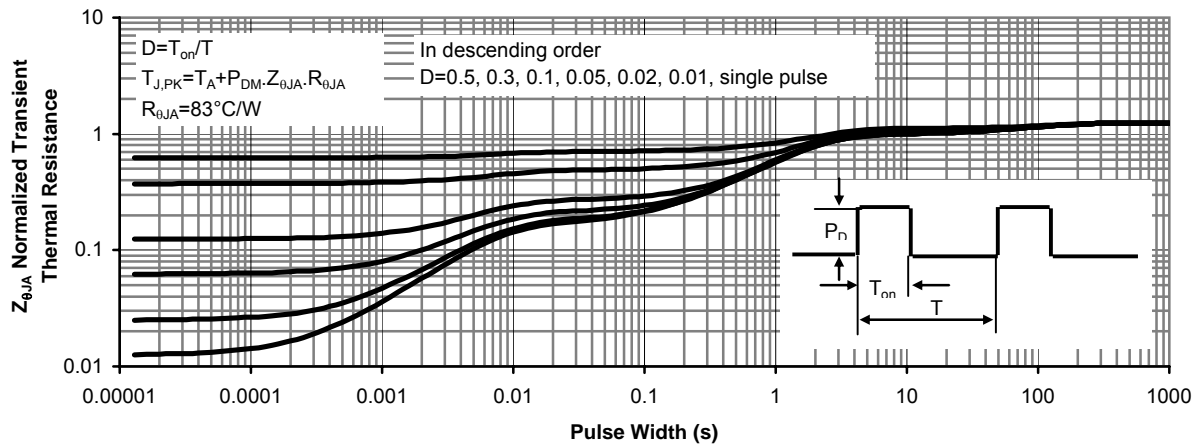
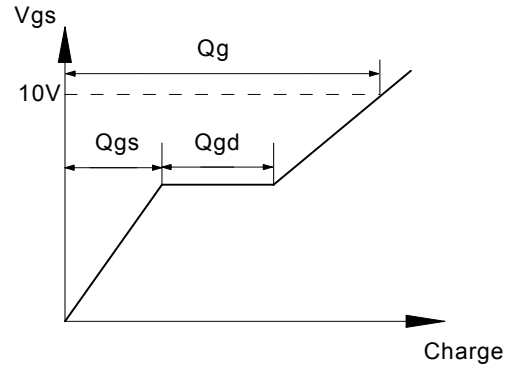
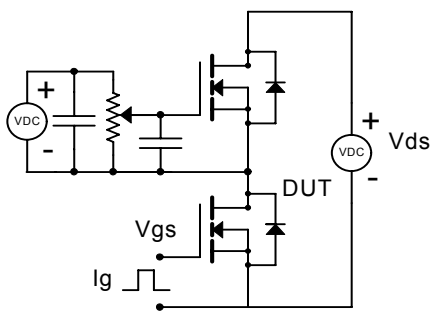
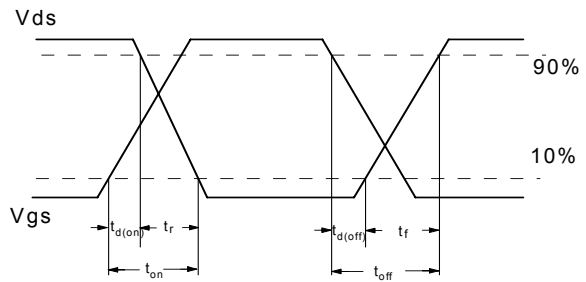
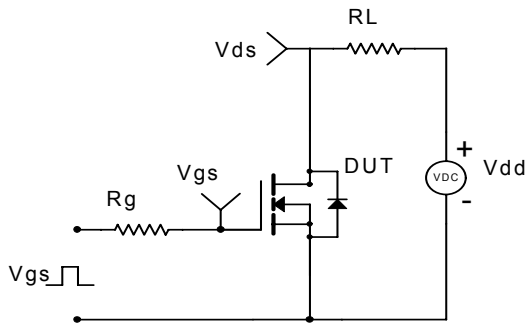

Figure 11: Normalized Maximum Transient Thermal Impedance

Gate Charge Test Circuit & Waveform



Resistive Switching Test Circuit & Waveforms



Diode Recovery Test Circuit & Waveforms

