

DM74164 8-Bit Serial In/Parallel Out Shift Registers

General Description

These 8-bit shift registers feature gated serial inputs and an asynchronous clear. A low logic level at either serial input inhibits entry of the new data, and resets the first flip-flop to the low level at the next clock pulse, thus providing complete control over incoming data. A high logic level on either input enables the other input, which will then determine the state of the first flip-flop. Data at the serial inputs may be changed while the clock is high or low, but only information meeting the setup and hold time requirements will be entered. Clocking occurs on the low-to-high level transition of the clock input. All inputs are diode-clamped to minimize transmission-line effects.

Features

- Gated (enable/disable) serial inputs
- Fully buffered clock and serial inputs
- Asynchronous clear
- Typical clock frequency 36 MHz
- Typical power dissipation 185 mW

Connection Diagram

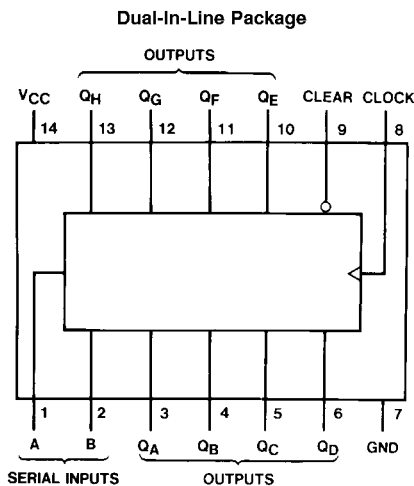

DS006552-1

Order Number 54164DMQB, 54164FMQB or DM74164N
See Package Number J14A, N14A or W14B

Function Table

Inputs			Outputs				
Clear	Clock	A	B	Q _A	Q _B	...	Q _H
L	X	X	X	L	L	...	L
H	L	X	X	Q _{A0}	Q _{B0}	...	Q _{H0}
H	↑	H	H	H	Q _{An}	...	Q _{Gn}
H	↑	L	X	L	Q _{An}	...	Q _{Gn}
H	↑	X	L	L	Q _{An}	...	Q _{Gn}

H = High Level (steady state), L = Low Level (steady state)

X = Don't Care (any input, including transitions)

↑ = Transition from low to high level

Q_{A0}, Q_{B0}, Q_{H0} = The level of Q_A, Q_B, or Q_H, respectively, before the indicated steady-state input conditions were established.

Q_{An}, Q_{Gn} = The level of Q_A or Q_G before the most recent ↑ transition of the clock; indicates a one-bit shift.

Absolute Maximum Ratings (Note 1)

Supply Voltage	7V	54	-55°C to +125°C
Input Voltage	5.5V	DM74	0°C to +70°C
Operating Free Air Temperature Range		Storage Temperature Range	-65°C to +150°C

Recommended Operating Conditions

Symbol	Parameter	54164			DM74164			Units
		Min	Nom	Max	Min	Nom	Max	
V _{CC}	Supply Voltage	4.5	5	5.5	4.75	5	5.25	V
V _{IH}	High Level Input Voltage	2			2			V
V _{IL}	Low Level Input Voltage			0.8			0.8	V
I _{OH}	High Level Output Current			-0.4			-0.4	mA
I _{OL}	Low Level Output Current			8			8	mA
f _{CLK}	Clock Frequency (Note 5)			25	0		25	MHz
t _w	Pulse Width (Note 5)	Clock	20		20			ns
		Clear	20		20			
t _{SU}	Data Setup Time (Note 5)	15			15			ns
t _H	Data Hold Time (Note 5)	0			5			ns
T _A	Free Air Operating Temperature	-55		125	0		70	°C

Note 1: The "Absolute Maximum Ratings" are those values beyond which the safety of the device cannot be guaranteed. The device should not be operated at these limits. The parametric values defined in the "Electrical Characteristics" table are not guaranteed at the absolute maximum ratings. The "Recommended Operating Conditions" table will define the conditions for actual device operation.

Electrical Characteristics

over recommended operating free air temperature range (unless otherwise noted)

Symbol	Parameter	Conditions	Min	Typ (Note 2)	Max	Units
V _I	Input Clamp Voltage	V _{CC} = Min, I _I = -14 mA			-1.5	V
V _{OH}	High Level Output Voltage	V _{CC} = Min, I _{OH} = Max V _{IL} = Max, V _{IH} = Min	2.4	3.2		V
V _{OL}	Low Level Output Voltage	V _{CC} = Min, I _{OL} = Max V _{IH} = Min, V _{IL} = Max		0.2	0.4	V
I _I	Input Current @ Max Input Voltage	V _{CC} = Max, V _I = 5.5V			1	mA
I _{IH}	High Level Input Current	V _{CC} = Max, V _I = 2.4V			40	μA
I _{IL}	Low Level Input Current	V _{CC} = Max, V _I = 0.4V			-1.6	mA
I _{OS}	Short Circuit Output Current (Note 3)	V _{CC} = Max	54	-10	-27.5	mA
		DM74		-9	-27.5	
I _{CC}	Supply Current	V _{CC} = Max (Note 4)		37	54	mA

Note 2: All typicals are at V_{CC} = 5V, T_A = 25°C.

Note 3: Not more than one output should be shorted at a time.

Note 4: I_{CC} is measured with all outputs open, SERIAL inputs grounded, the CLOCK input at 2.4V, and a momentary ground, then 4.5V, applied to the CLEAR input.

Note 5: T_A = 25°C and V_{CC} = 5V.

Switching Characteristics

at $V_{CC} = 5V$ and $T_A = 25^\circ C$

Symbol	Parameter	From (Input) To (Output)	$R_L = 800\Omega$				Units
			$C_L = 15\text{ pF}$		$C_L = 50\text{ pF}$		
			Min	Max	Min	Max	
f_{MAX}	Maximum Clock Frequency		25				MHz
t_{PLH}	Propagation Delay Time Low to High Level Output	Clock to Output		27		30	ns
t_{PHL}	Propagation Delay Time High to Low Level Output	Clock to Output		32		37	ns
t_{PHL}	Propagation Delay Time High to Low Level Output	Clear to Output		36		42	ns

Logic Diagram

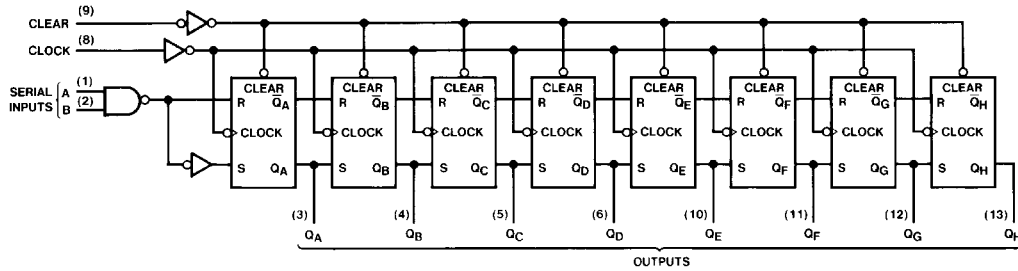

DS006552.2

Timing Diagram

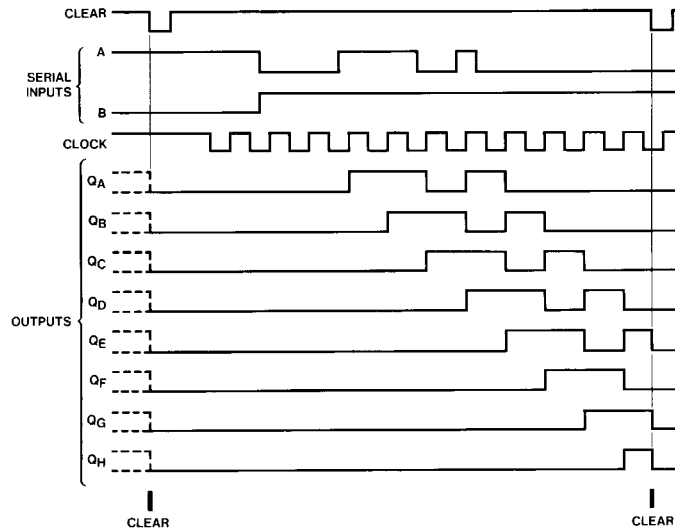

DS006552.3

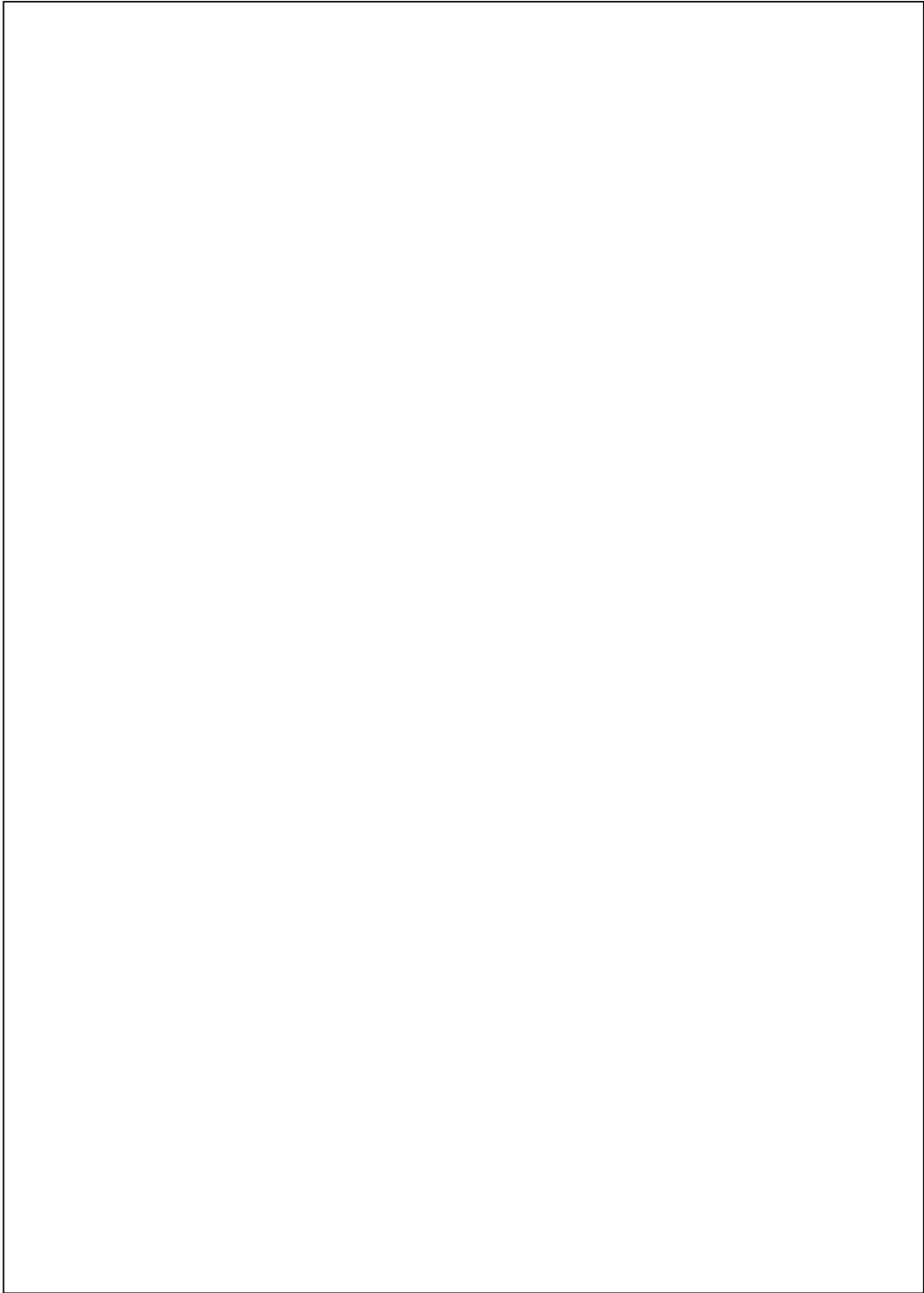

Physical Dimensions inches (millimeters) unless otherwise noted

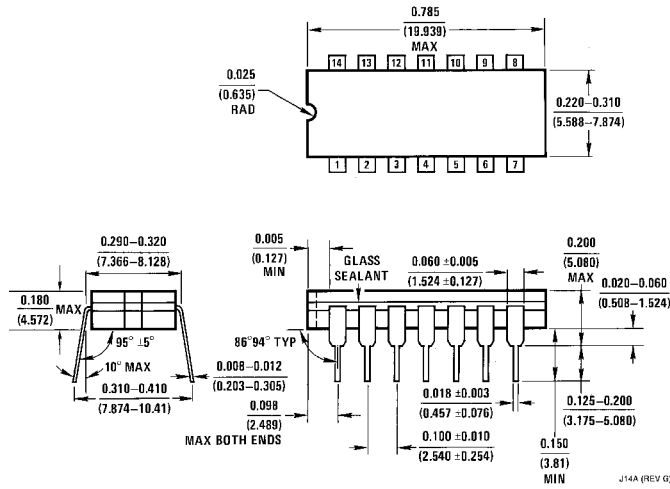

14-Lead Ceramic Dual-In-Line Package (J)
Order Number 54164DMQB
Package Number J14A

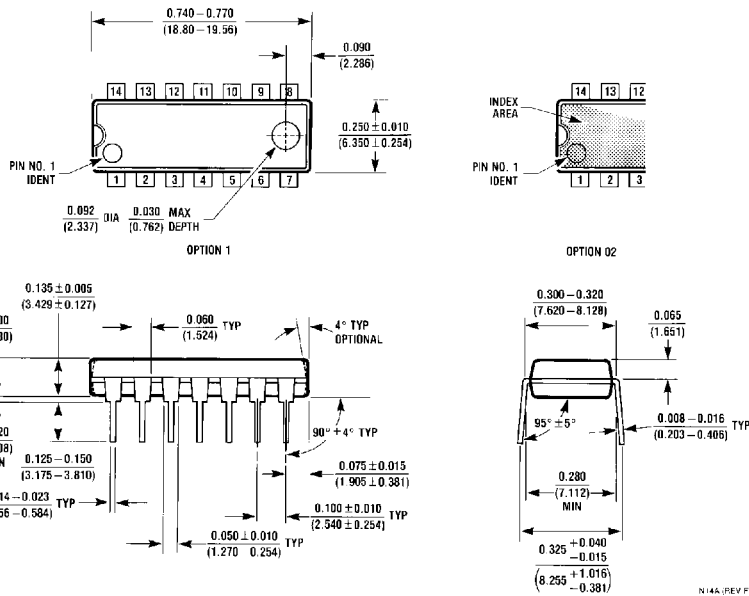

14-Lead Molded Dual-In-Line Package (N)
Order Number DM74164N
Package Number N14A

Physical Dimensions inches (millimeters) unless otherwise noted (Continued)

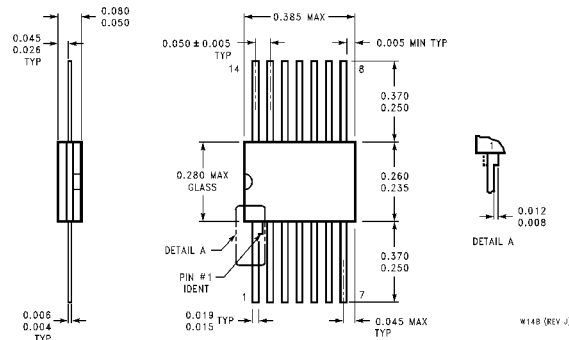

14-Lead Ceramic Flat Package (W)
Order Number 54164FMQB
Package Number W14B

W14B (REV J)

LIFE SUPPORT POLICY

FAIRCHILD'S PRODUCTS ARE NOT AUTHORIZED FOR USE AS CRITICAL COMPONENTS IN LIFE SUPPORT DEVICES OR SYSTEMS WITHOUT THE EXPRESS WRITTEN APPROVAL OF THE PRESIDENT OF FAIRCHILD SEMICONDUCTOR CORPORATION. As used herein:

1. Life support devices or systems are devices or systems which, (a) are intended for surgical implant into the body, or (b) support or sustain life, and (c) whose failure to perform when properly used in accordance with instructions for use provided in the labeling, can be reasonably expected to result in a significant injury to the user.
2. A critical component in any component of a life support device or system whose failure to perform can be reasonably expected to cause the failure of the life support device or system, or to affect its safety or effectiveness.

Fairchild Semiconductor Corporation Americas
 Customer Response Center
 Tel: 1-888-522-5372

Fairchild Semiconductor Europe
 Fax: +49 (0) 1 80-530 85 86
 Email: europe.support@nsc.com
 Deutsch Tel: +49 (0) 8 141-35-0
 English Tel: +44 (0) 1 793-85-68-56
 Italy Tel: +39 (0) 2 57 5631

Fairchild Semiconductor Hong Kong Ltd.
 13th Floor, Straight Block,
 Ocean Centre, 5 Canton Rd.
 Tsimshatsui, Kowloon
 Hong Kong
 Tel: +852 2737-7200
 Fax: +852 2314-0061

National Semiconductor Japan Ltd.
 Tel: 81-3-5620-6175
 Fax: 81-3-5620-6179

www.fairchildsemi.com